

President & Cabinet

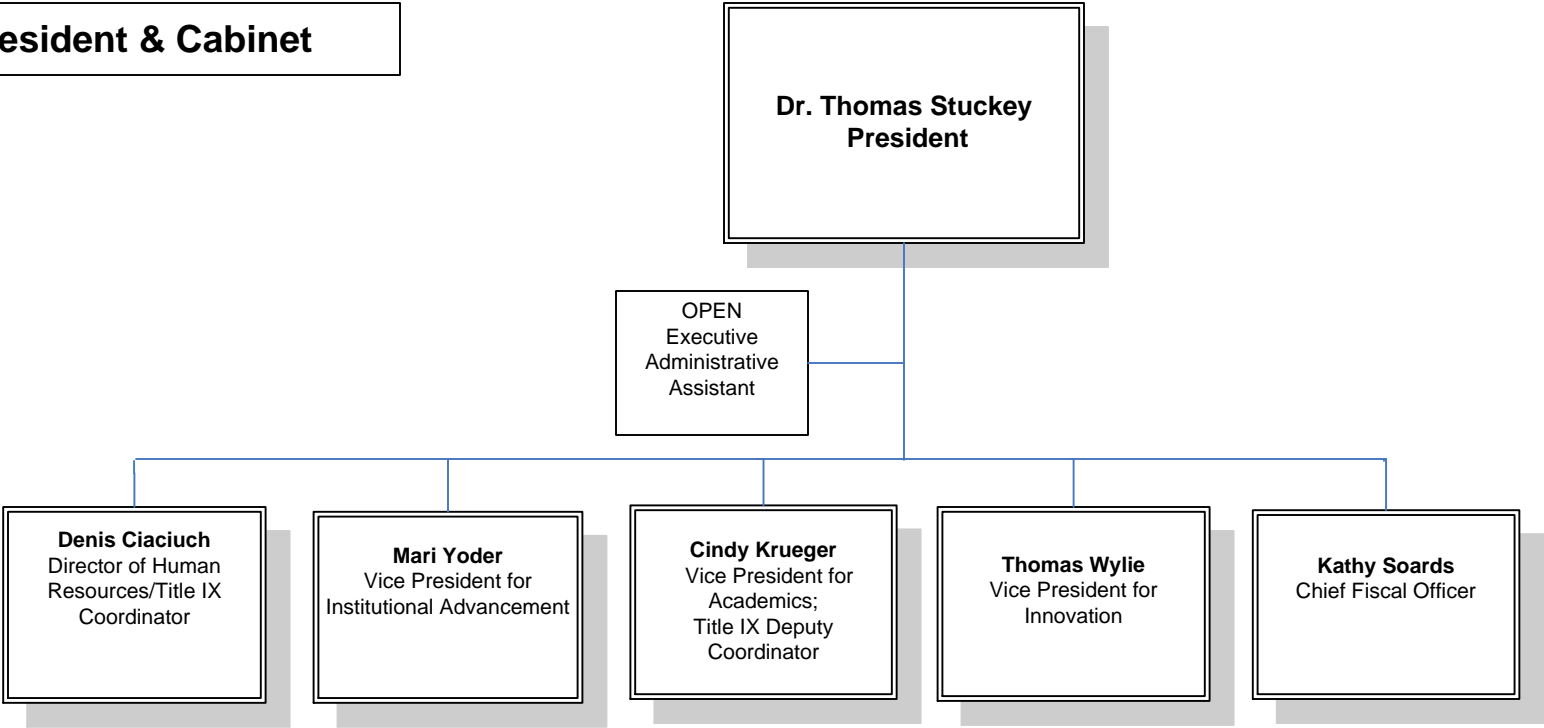

Academics

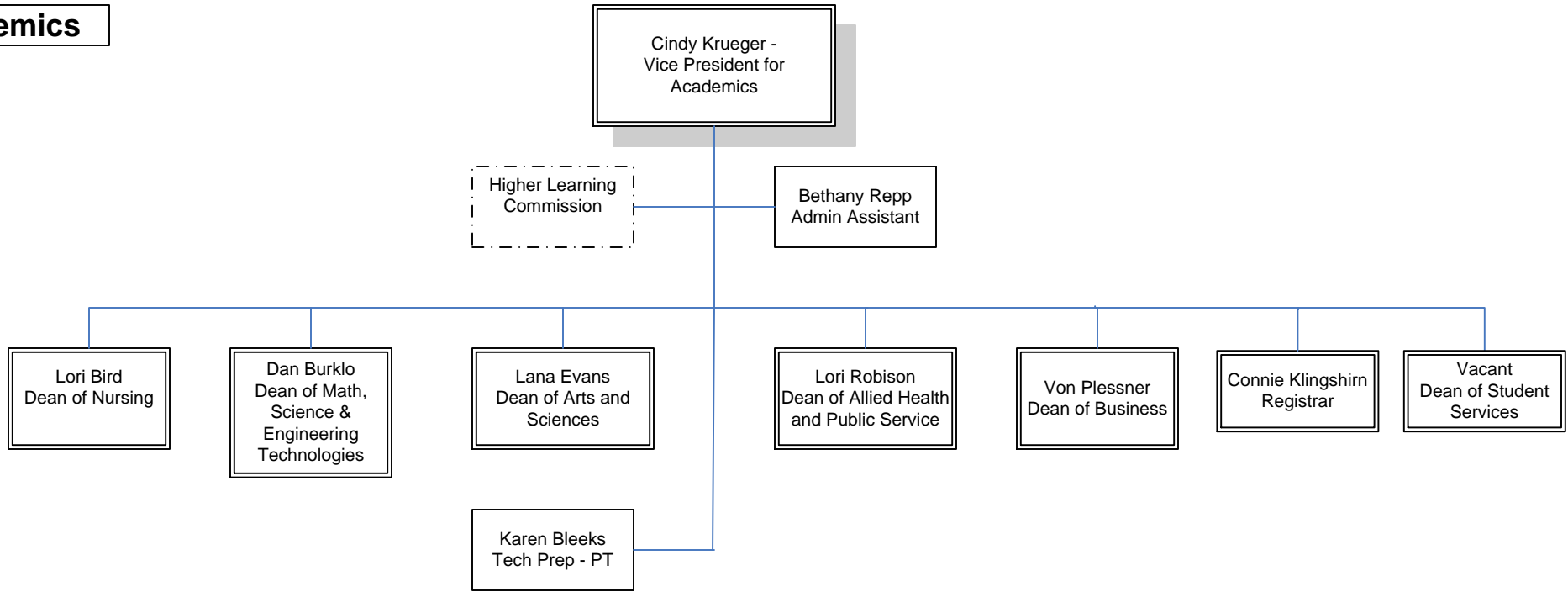

Revised
January 16, 2013

Allied Health & Public Service

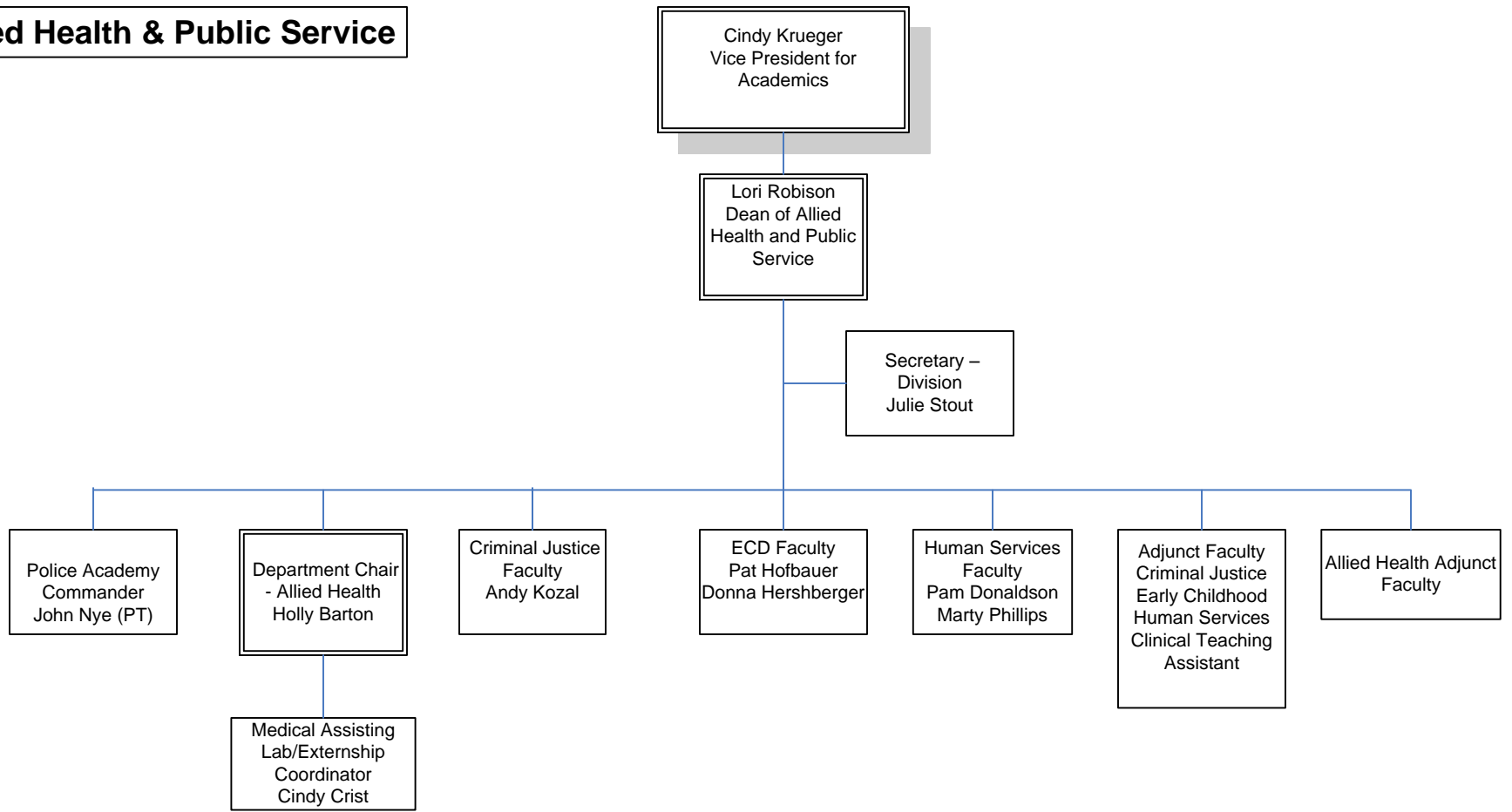

Revised
January 16, 2013

Arts & Sciences

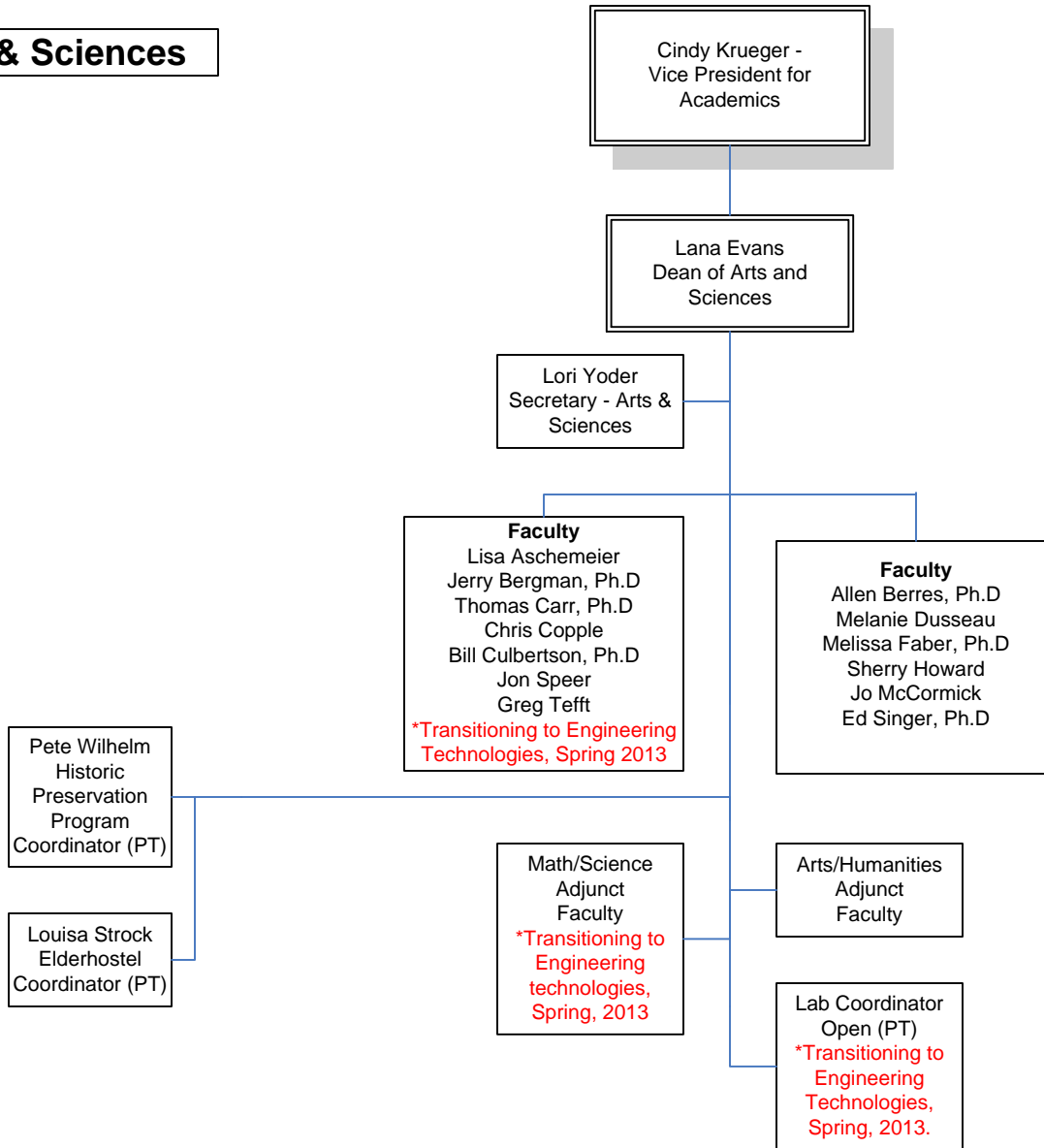

Business Technologies

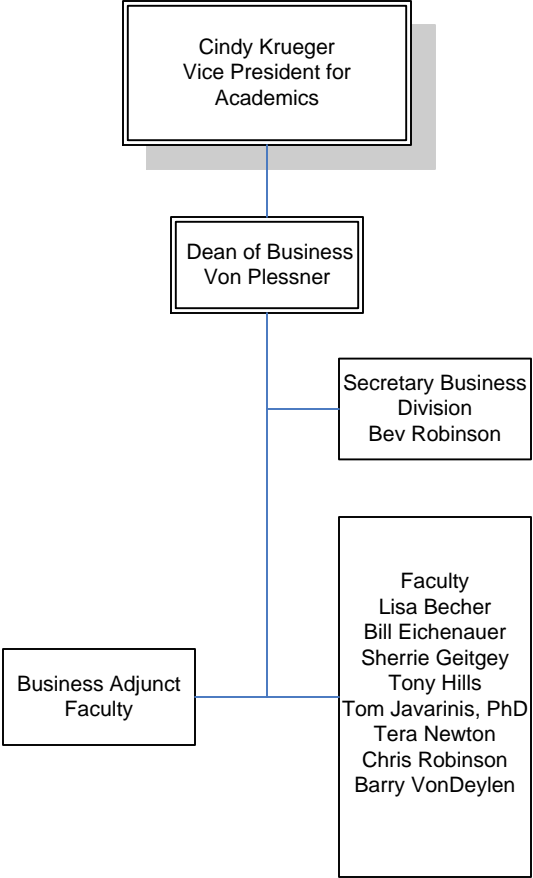

Engineering Technologies

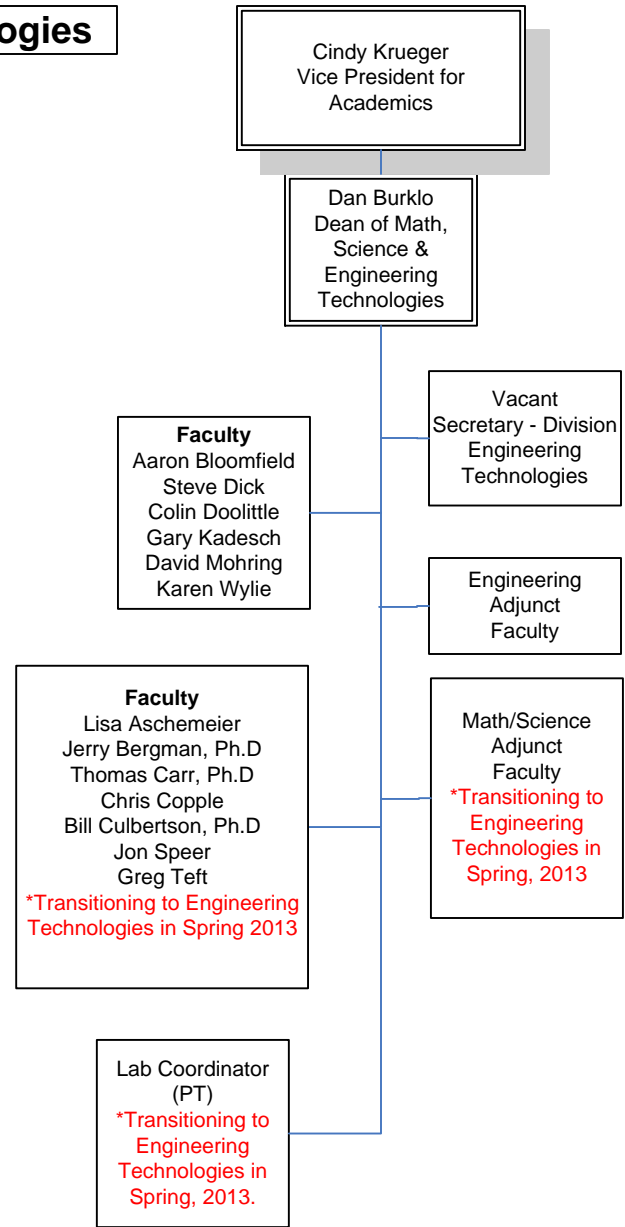

Revised
January 16, 2013

Nursing

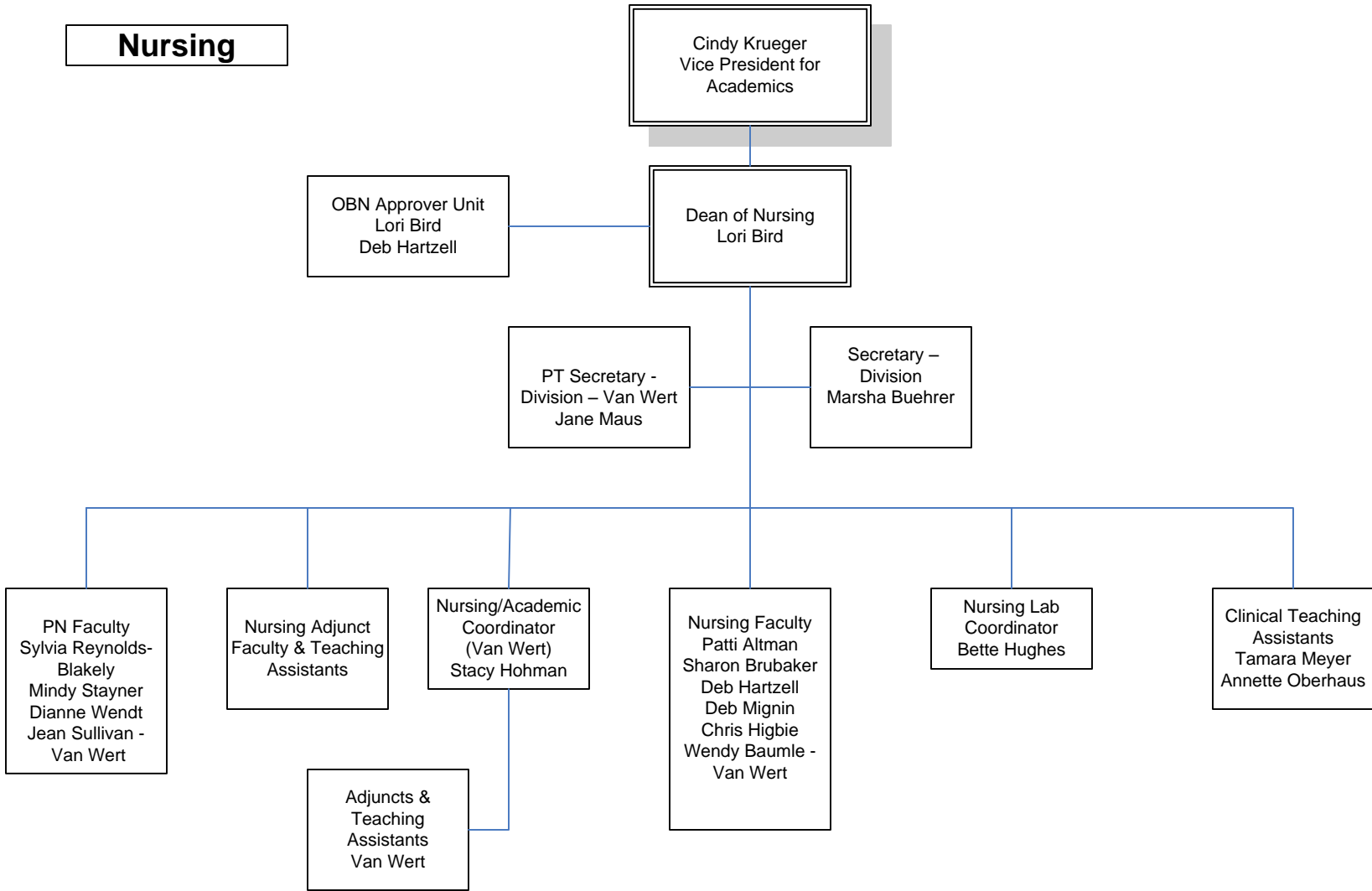

Business Services

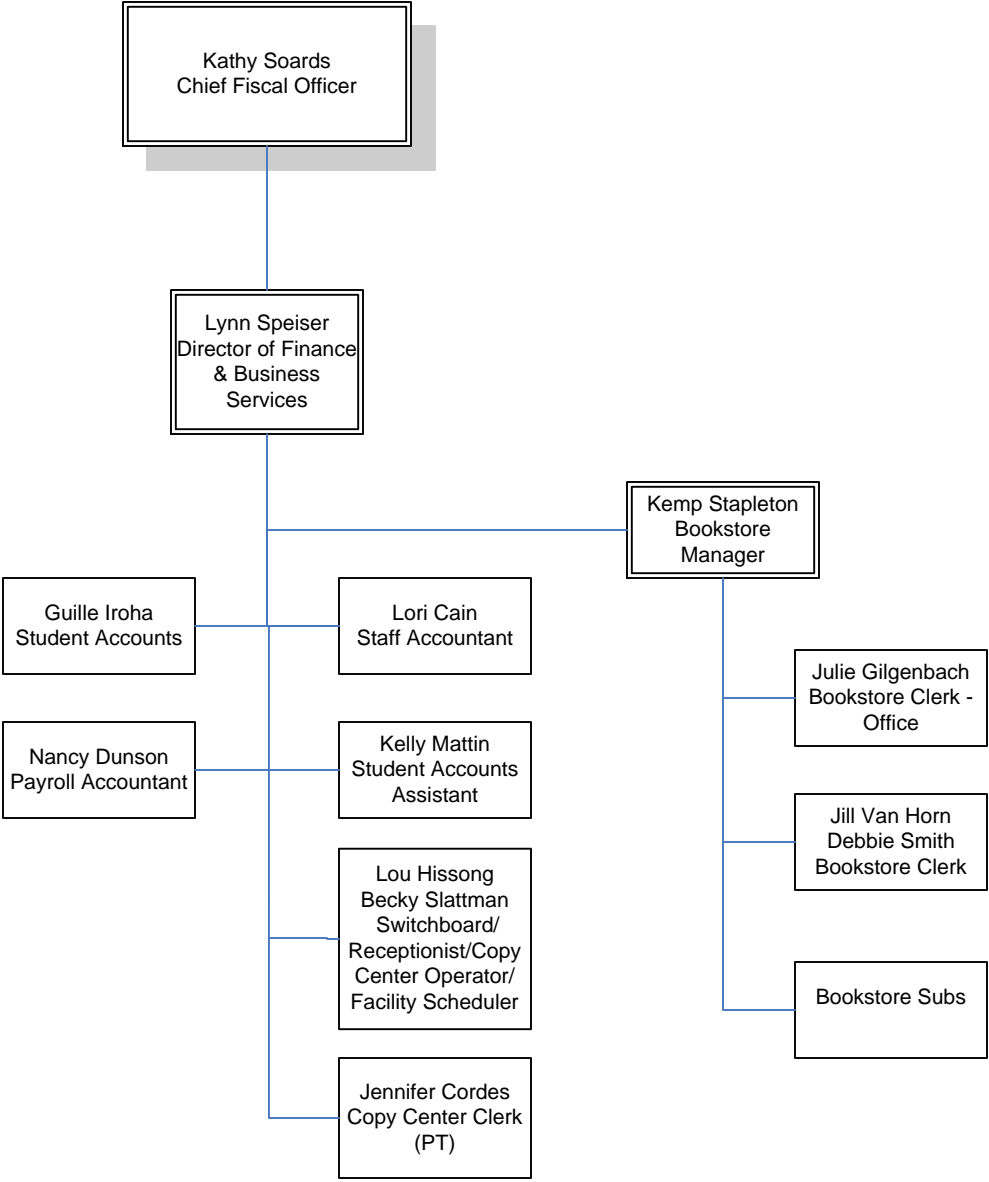

Revised
January 16, 2013

Financial Aid

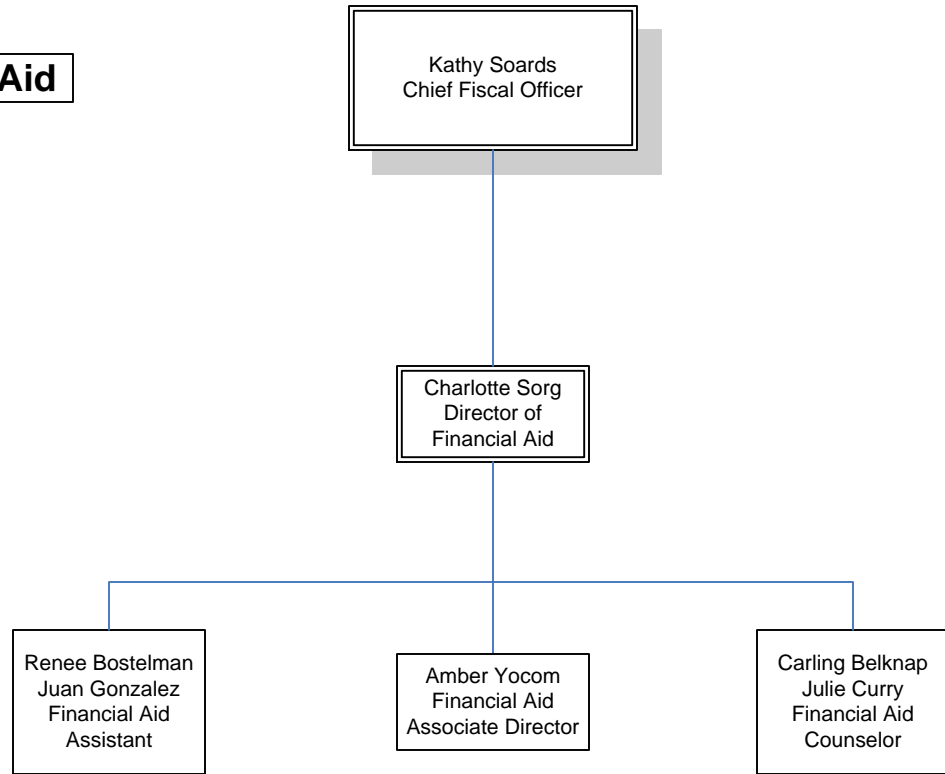

Revised
January 16, 2013

Fiscal Operations

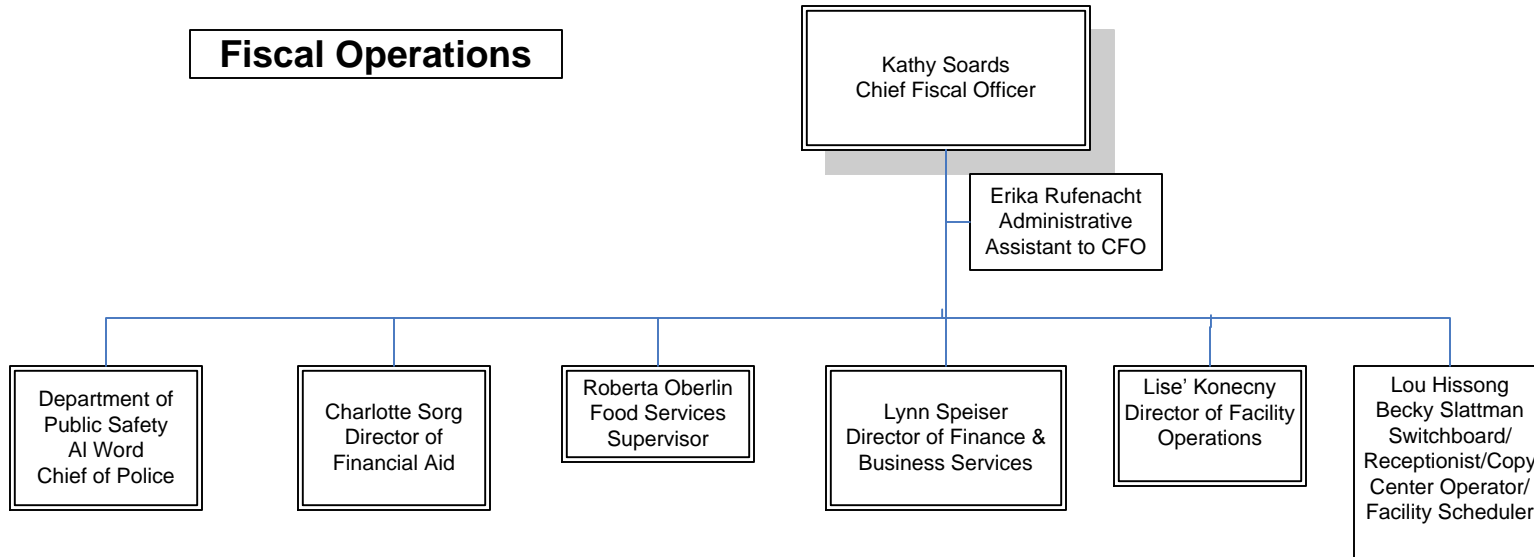

Revised
January 16, 2013

Human Resources

Denis Ciaciuch
Director of Human
Resources/Title IX
Coordinator

Lisa Ramirez
Employment &
Benefits
Supervisor/Title IX
Deputy Coordinator

Revised
January 16, 2013

Information Technology

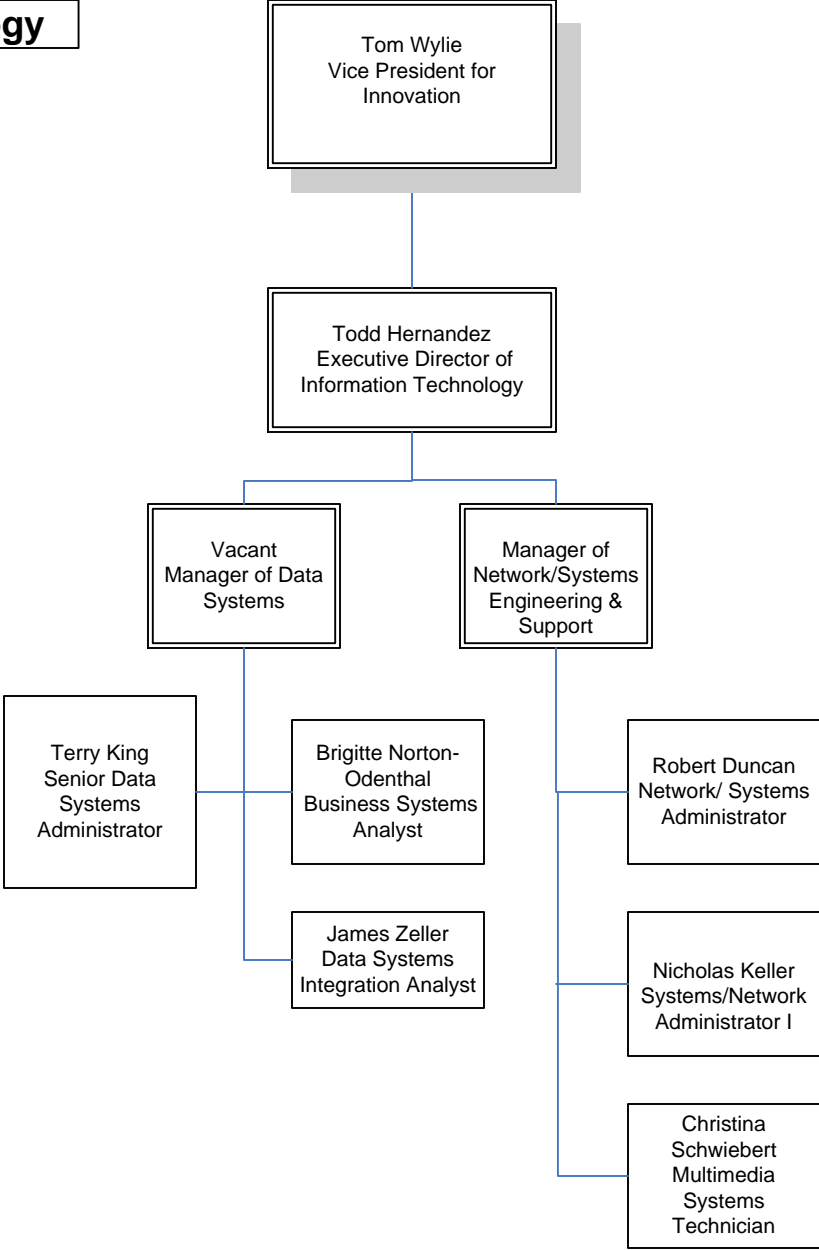

Institutional Advancement

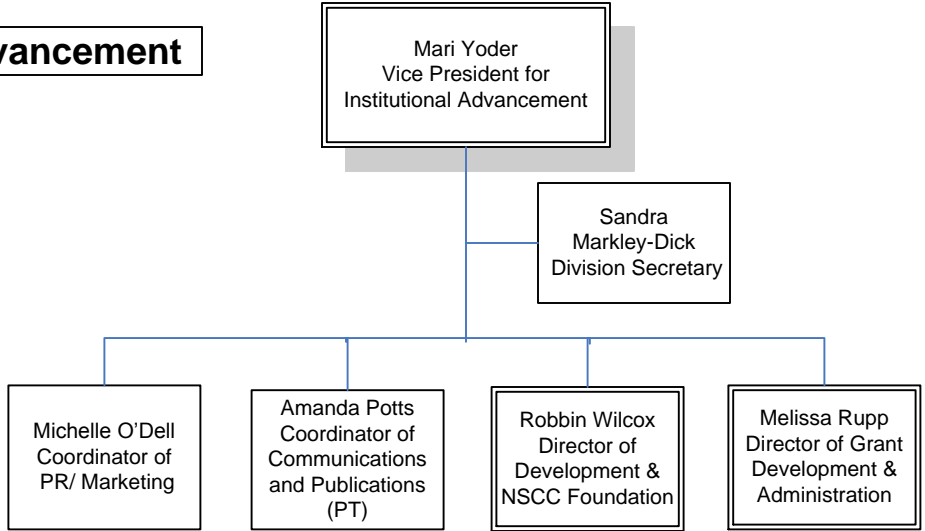

Operations

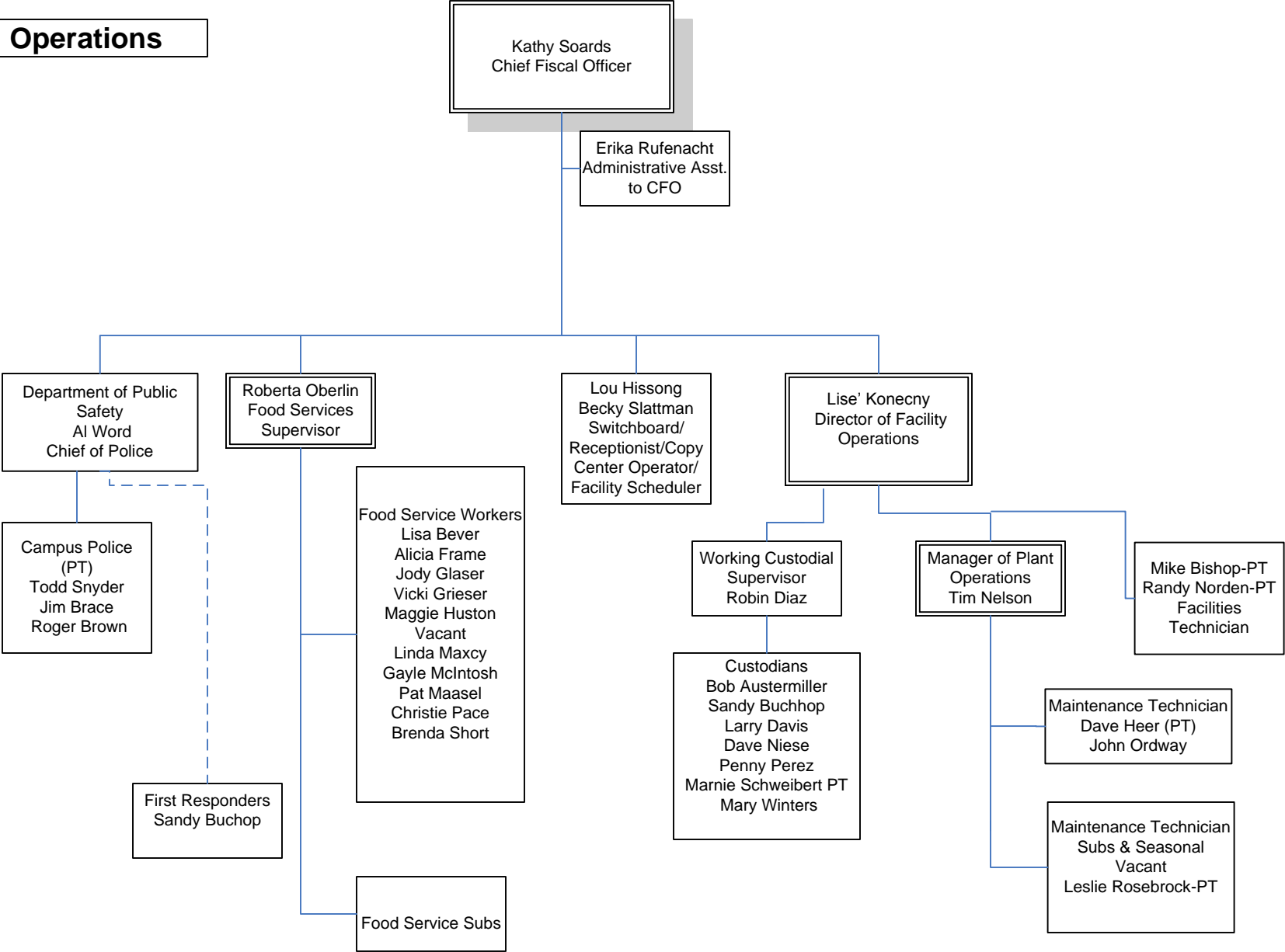

Registrar

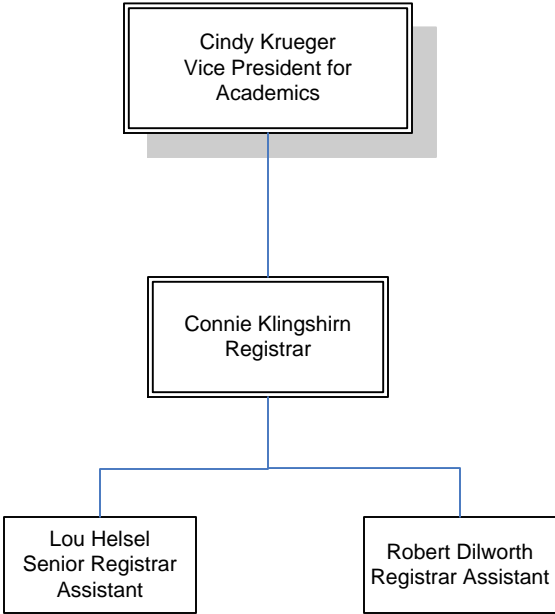

Revised
January 16, 2013

Student Services

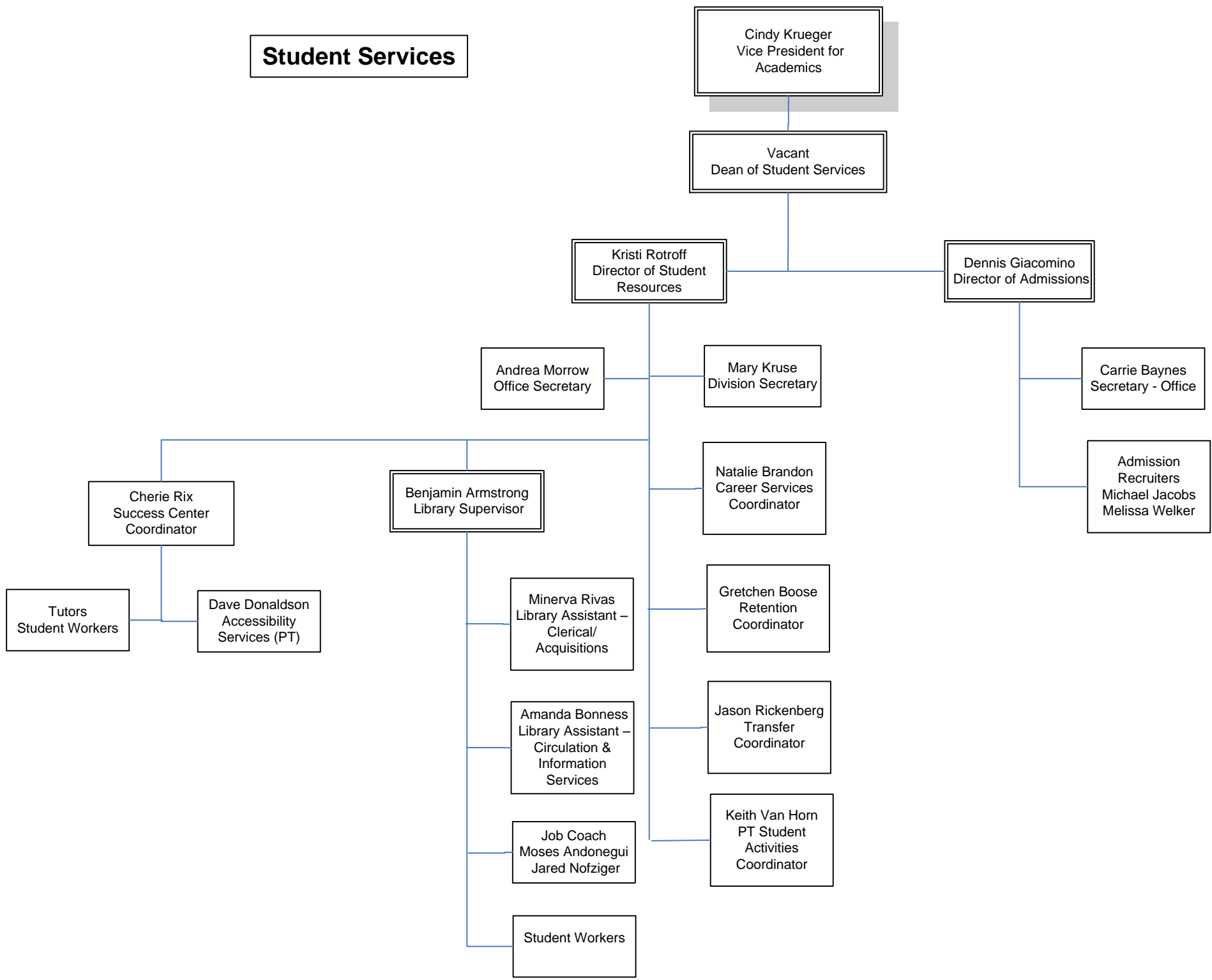

Workforce Development

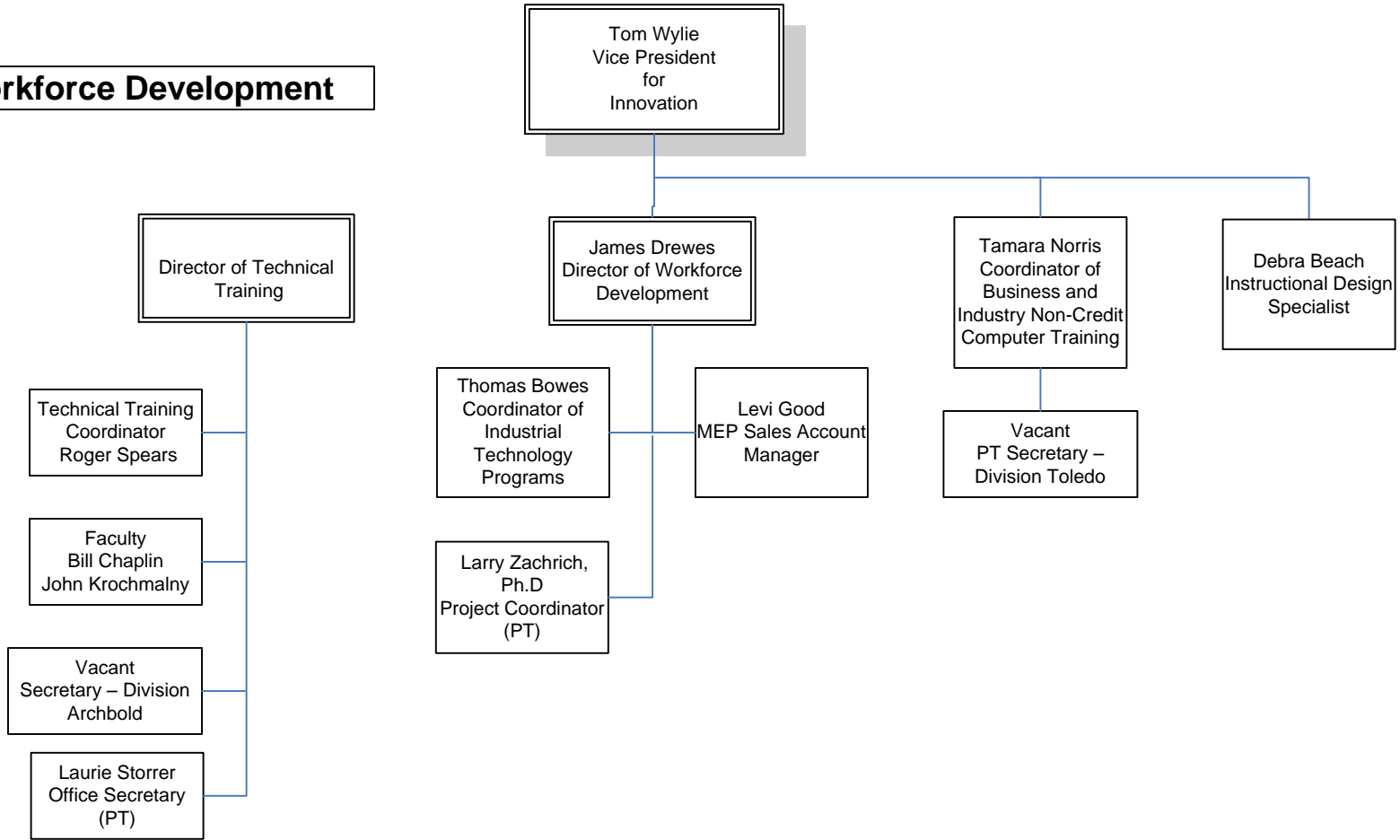

Revised
January 16, 2013